



Electrolux
PROFESSIONAL

**Beverage Dispensing System
Hot Chocolate Dispenser, 6 L,
black**

ITEM # _____

MODEL # _____

NAME # _____

SIS # _____

AIA # _____

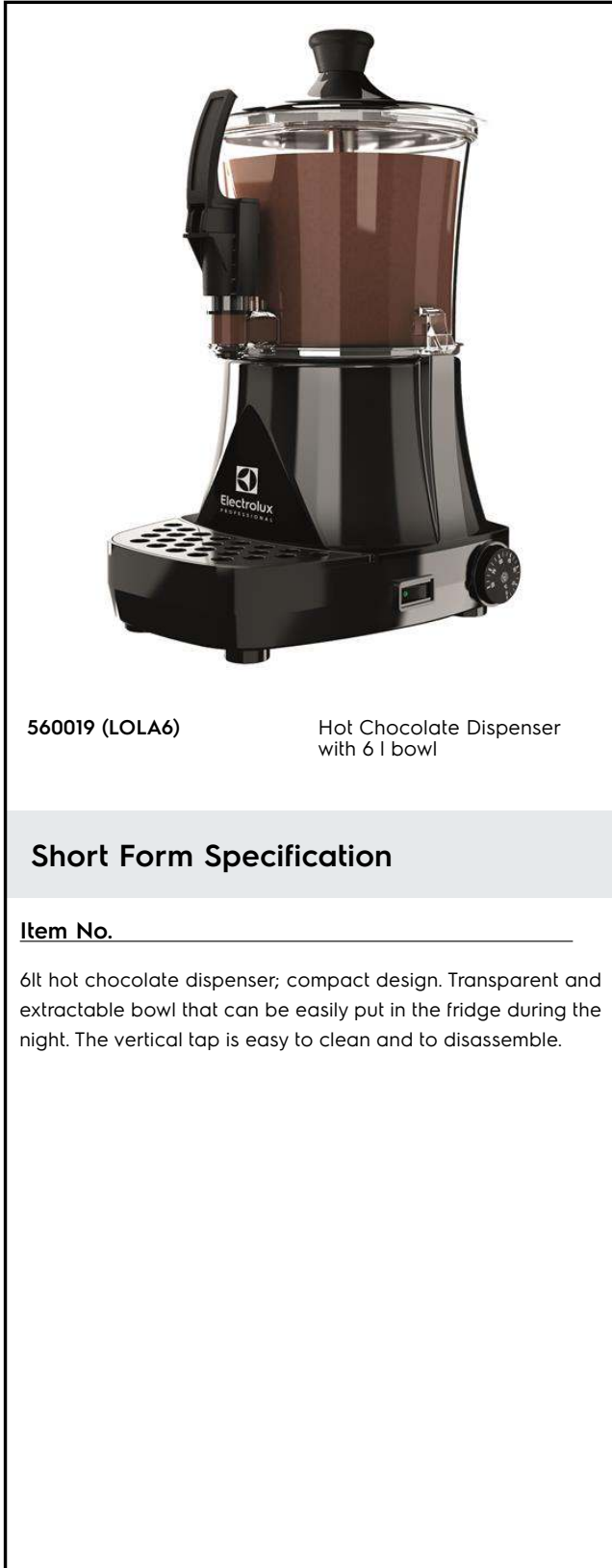

560019 (LOLA6)

Hot Chocolate Dispenser
with 6 l bowl

Short Form Specification

Item No. _____

6lt hot chocolate dispenser; compact design. Transparent and extractable bowl that can be easily put in the fridge during the night. The vertical tap is easy to clean and to disassemble.

Main Features

- Hot chocolate dispenser ideal also for small places thanks to its compact design.
- Transparent and extractable bowl that can be easily put in the fridge during the night.
- The vertical tap is easy to clean and to disassemble.

APPROVAL: _____



Experience the Excellence
www.electroluxprofessional.com

**Beverage Dispensing System
Hot Chocolate Dispenser, 6 L, black**

Front

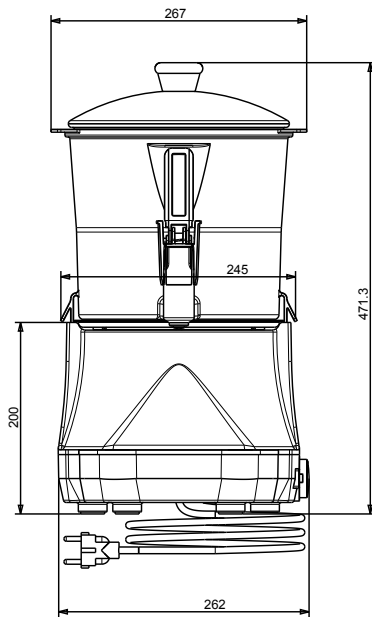

Side

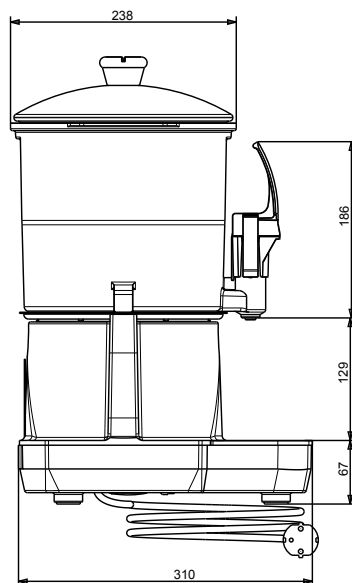

Top

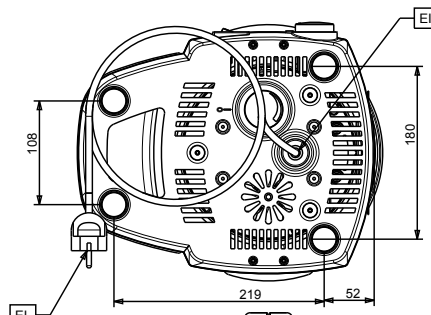

Electric

Supply voltage:

560019 (LOLA6) 220-240 V/1 ph/50 Hz

Electrical power max.:

0.85 kW

Key Information:

External dimensions, Width: 270 mm

External dimensions, Height: 465 mm

External dimensions, Depth: 318 mm

Net weight: 6.2 kg

Shipping weight: 8 kg

Shipping height: 530 mm

Shipping width: 350 mm

Shipping depth: 380 mm

Shipping volume: 0.07 m³